

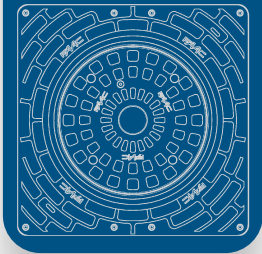

J SERIES BOLLARDS

FAAC
Simply automatic.



Bollards Series



FAAC bollards range.

Endless solutions, performance beyond the standard

**Innovative solutions to meet
any application need**

**FAAC Hydraulic Technology,
over 50 years of worldwide excellence**

**High quality components
to ensure exceptional performance**

**«Design for Assembly» approach; products
designed to simplify installation and maintenance**

**The strength of the FAAC Group;
worldwide presence to support your project**

Jseries



J200 Series for residential areas

(HA) Automatic

To regulate vehicle access to residential areas

(SA) Semi-Automatic

To regulate access to areas that are occasionally open to traffic; it doesn't need to be wired.

(F) Fixed

To complete installations with other retractable models for access control



J275 Series for commercial, industrial and urban restricted access areas

(HA) Automatic

To regulate vehicular access to commercial, industrial and urban restricted access areas

(SA) Semi-Automatic

To regulate vehicle access to town centres, areas that are difficult to wire or occasionally open to traffic

(F) Fixed

To complete installations with other retractable models for access control



J275 2K20 Series perimeter security

(HA) Automatic

Vehicular access control in critical areas, like: banks, marine zones, prisons, industrial sites or wherever is required an high security level

(F) Fixed

Delimitation and protection of perimeter of critical areas



Bollards for vehicular access control in residential areas



500





978

1. J200 HA AUTOMATIC RETRACTABLE TRAFFIC BOLLARD

The Automatic retractable traffic bollard FAAC J200 HA is particularly suitable to regulate vehicle traffic in residential areas, ensuring an intelligent control, while maintaining the aesthetic appearance.

2. J200 SA SEMI-AUTOMATIC TRAFFIC BOLLARD

This bollard solves transit and/or parking control problems without needing electrical power (making it particularly suitable for use in historical city centres and areas which are difficult to wire). The bollard is key-operated and automatically lifted by a gas operator. The bollard is lowered by using the same key and pressing on the head.

3. J200 F FIXED TRAFFIC BOLLARD

The Fixed traffic bollard FAAC J200 does not require invasive installation work, nor electrical wiring. It is therefore ideal for permanent installations to define residential pedestrian areas, or for mixed installations which also feature other automatic or semi-automatic bollards.





J200 HA AUTOMATIC retractable traffic bollard

1. Easy to transport, store and install, thanks to the self-supporting structure and to the limited weight of the product
2. Easy underground pit laying and limited excavation
3. A streamlined product, configurable by selecting the desired installation accessories
4. Easy maintenance (can be performed by a single person)
5. Integrated hydraulic unit



DIMENSIONS AND TECHNICAL SPECIFICATIONS

Model	J200 HA H600	J200 HA H600 INOX
Type of operator	Hydraulic operator	
Cylinder height from ground	600 mm	
Cylinder diameter	200 mm	
Cylinder material	Steel S235JRG2 EN 10277 (6 mm thick)	Satin-finished AISI 316L (6 mm thick)
Cylinder treatment	Cataphoresis and polyester powder paint, dark grey metallised RAL 7021	Satin finish
Rising time	~5 s (*)	
Descent time	~7 s (*)	
Emergency descent device	YES (optional)	
Emergency descent time	~7 s (*)	
Rising obstacle detection device	YES (optional)	
Release device	YES	
Power supply voltage	220-240V ~ 50/60Hz	
Max. power	230 W (*)	
Hydraulic pump unit protection class	IP67	
Type of use	Use in residential areas	
Total weight	90 Kg	
Operating ambient temperature	-15 °C / +55 °C	
Operating ambient temperature with heater	-25 °C / +55 °C	

(*) Data referred to 230V-50Hz

J200 HA

PAINTED STEEL VERSION

Model	Height	Finish	Item code
J200 HA 600	600 mm	Painted steel	116500

The product comes with:

- 6 mm thick steel cylinder with cathoresis treatment and painted
- powder coated dark grey metallised RAL 7021
- hydraulic lock in raised position (in the event of a power cut) with special release key standard supplied (1 pc.)
- support structure to be cemented with cathoresis treatment (pits not required)

AISI 316L STAINLESS STEEL VERSION

Model	Height	Finish	Item code
J200 HA 600	600 mm	satin-finished AISI 316L stainless steel	116505





The product comes with:

- 6 mm thick stainless steel cylinder with satin-finish treatment
- hydraulic lock in raised position (in the event of a power cut) with special release key standard supplied (1 pc.)
- support structure to be cemented with cathoresis treatment (pits not required)

ELECTRONIC EQUIPMENT

Item	Item code	
Electronic control unit	117300	

OPTIONAL ACCESSORIES

Item	Item code	
Pit heater J200HA (to extend operation up to -25°C)	116501	
Release kit with pressure switch for J200 HA	116502	
Acoustic buzzer J200 HA	116503	
LED lights kit J200 HA	116504	





J200 SA SEMI-AUTOMATIC traffic bollard

1. Power supply and wiring not requested
2. Simple and safe movement, thanks to the specific unlocking key
3. Easy to transport, store and install, thanks to the limited weight of the product
4. Kept lock in rised position (against accidental release)



DIMENSIONS AND TECHNICAL SPECIFICATIONS

Model	J200 SA H600	J200 SA H600 Stainless steel
Type of operator	Single-acting gas operator	
Cylinder height from ground	600 mm	
Cylinder diameter	200 mm	
Cylinder material	Steel S235JRG2 EN 10277 (6 mm thick)	Satin-finished AISI 316L (6 mm thick)
Cylinder treatment	Cataphoresis and polyester powder paint, dark grey metallised RAL 7021	Satin finish
Release device	Key operated (supplied)	
Reflective strip height	25 mm	
Standard reflecting strip colour	Orange	
Total weight	82 Kg	
Walled in pit with cylinder profile (LxWxH)	400 x 500 x 800 mm	
Excavation dimensions (LxWxH)	700 x 700 x 1,100 mm	

J200 SA

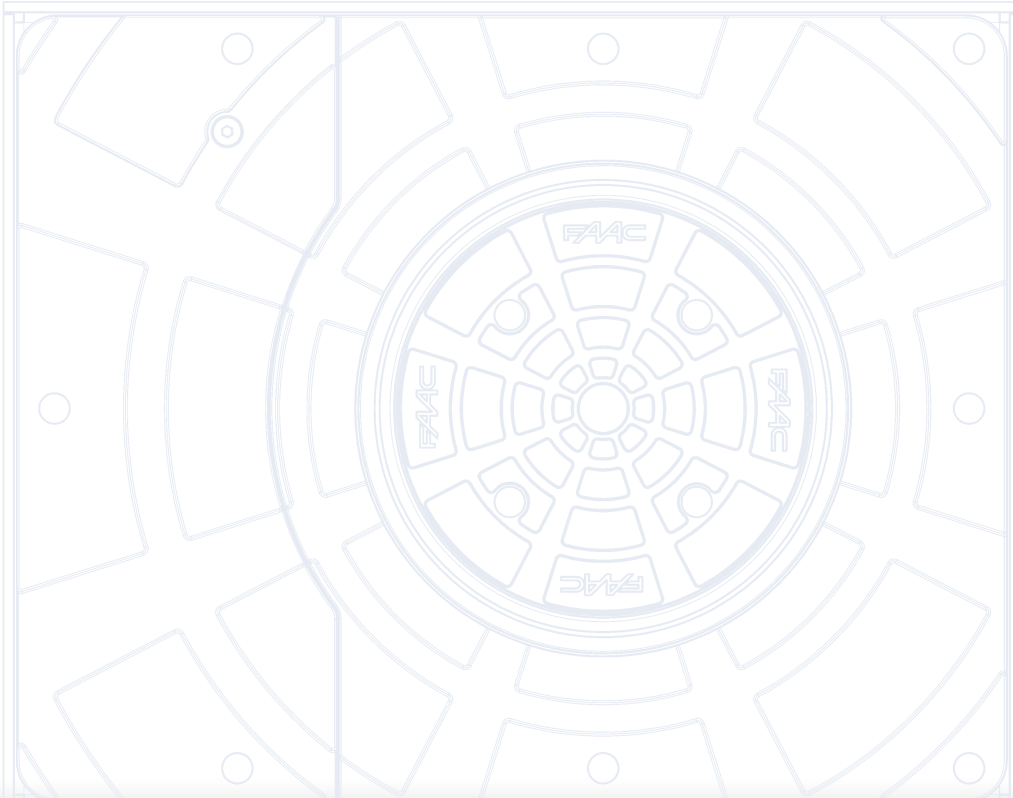

PAINTED STEEL VERSION

Model	Height	Finish	Item code
J200 SA 600	600 mm	Painted steel	116508

The product comes with:

- 6 mm thick steel cylinder with cathoporesis treatment and painted
- powder paint, dark grey metallised RAL 7021
- support structure to be cemented with cathoporesis treatment (pits not required)
- release key (1 piece)

AISI 316L STAINLESS STEEL VERSION

Model	Height	Finish	Item code
J200 SA 600	600 mm	Satin-finished AISI 316L stainless steel	116509

The product comes with:

- 6 mm thick stainless steel cylinder with satin-finished treatment
- support structure to be cemented with cathoporesis treatment (pits not required)
- release key (1 piece)

OPTIONAL ACCESSORIES

Item	Item code	
Release keys kit (5 keys)	390084	
LED lights kit J200*	116504	

(*) The power supply unit (24 Vdc) and the cable (2x1.5 mm) for the flashing light are not supplied.



J200 F FIXED traffic bollard

1. Power supply and wiring not required
2. Simple installation and limited digging operations
3. Observance of aesthetic consistency in mixed installations with other retractable bollards

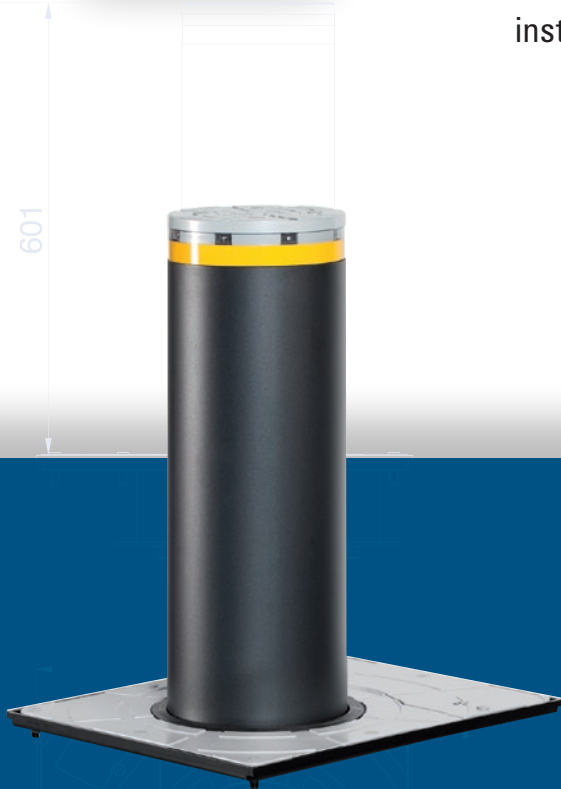

DIMENSIONS AND TECHNICAL SPECIFICATIONS

Model	J200 F H600	J200 F H600 Stainless steel
Cylinder height from ground	600 mm	
Cylinder diameter	200 mm	
Cylinder material	Steel S235JRG2 EN 10277 (6mm thick)	Satin-finished AISI 316L (6mm thick)
Cylinder treatment	Cataphoresis and polyester powder paint, dark grey metallised RAL 7021	Satin finish
Reflective strip height	25 mm	
Standard reflecting strip colour	Orange	
Total weight	35 Kg	

J200 F



PAINTED STEEL VERSION

Model	Height	Finish	Item code
J200 F 600	600 mm	powder paint, dark grey metallised RAL 7021	116506

The product comes with:

- 6 mm thick stainless steel cylinder with satin-finished treatment
- Powder paint, dark grey metallised RAL 7021

AISI 316L STAINLESS STEEL VERSION

Model	Height	Finish	Item code
J200 F 600	600 mm	satin-finished AISI 316L stainless steel	116507

The product comes with:

- 6 mm thick stainless steel cylinder with satin-finished treatment

OPTIONAL ACCESSORIES

Item	Item code	
LED lights kit J200*	116504	

(*) The power supply unit (24 Vdc) and the cable (2x1.5 mm) for the flashing light are not supplied.





Bollards for vehicular access control in commercial, industrial and urban restricted access areas

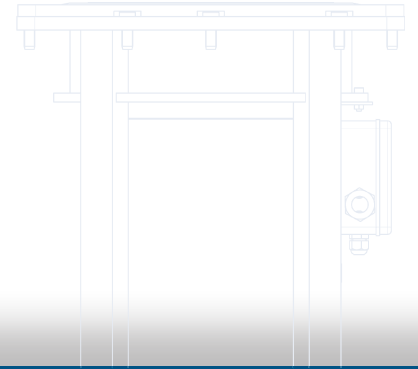
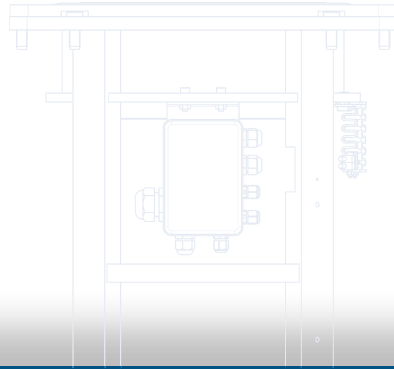



1. J275 HA V2 AUTOMATIC RETRACTABLE TRAFFIC BOLLARD

The Automatic retractable traffic bollard J275 HA V2 is recommended for all areas when many daily transits are expected, i.e. commercial, industrial and urban restricted access areas.

2. J275 SA SEMI-AUTOMATIC RETRACTABLE TRAFFIC BOLLARD

The Semi-Automatic retractable traffic bollard J275 SA is particularly suitable for town centres and areas difficult to wire.

In fact, thanks to a gas actuator, raising and lowering is fully mechanical and does not require any electrical connection.

3. J275 F FIXED TRAFFIC BOLLARD

The Fixed traffic bollard FAAC J275 does not require invasive installation work, nor electrical wiring. It is therefore ideal for permanent installations to define pedestrian areas, or for mixed installations which also feature other retractable bollards.

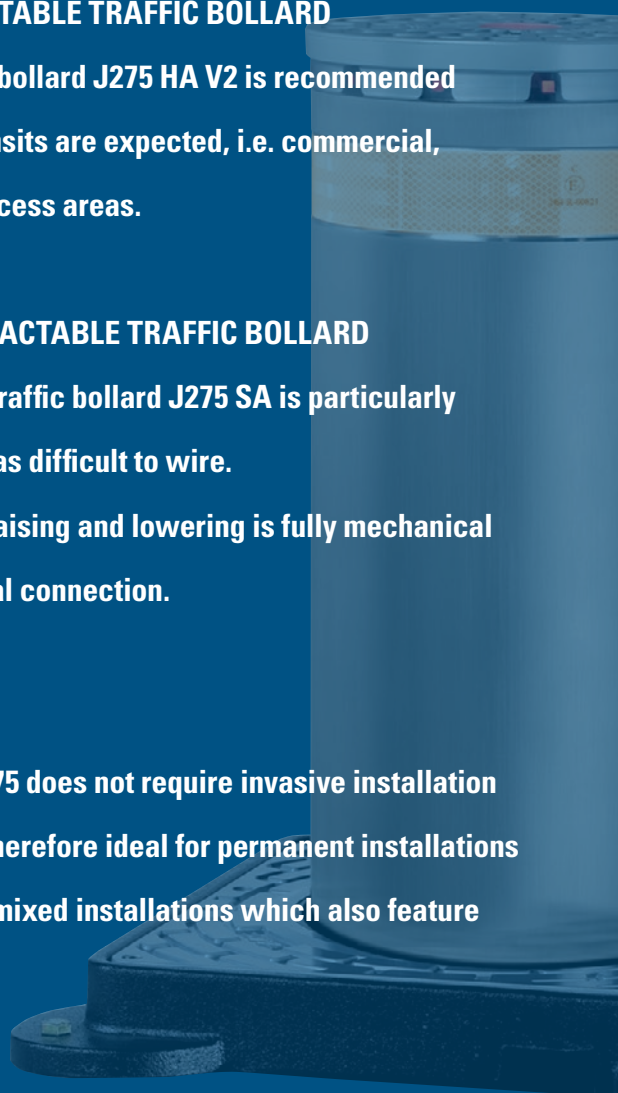



J275 HA V2 AUTOMATIC retractable traffic bollard

1. Guaranteed for high frequency use
2. "Full optional" product; supplied equipped with the main accessories
3. Simplified maintenance (possible with just one person)
4. Integrated hydraulic unit
5. Perfect interchangeability with first generation bollards
6. "Gentle stop" function to guarantee a soft impact while arriving on the low limit



DIMENSIONS AND TECHNICAL SPECIFICATIONS

Model	J275 HA V2 H600	J275 HA V2 H800	J275 HA V2 H600 INOX	J275 HA V2 H800 INOX
Type of operator	Hydraulic Actuator			
Cylinder height from ground	600 mm	800 mm	600 mm	800 mm
Cylinder diameter	275 mm			
Cylinder material	Steel S235JR EN 10219 (7mm thick)		Satin-finished AISI 316L (6mm thick)	
Cylinder treatment	Cataphoresis and polyester powder paint, dark grey metallised RAL 7021		Satin finish	
Rising time	~5 s (*)	~7 s (*)	~5 s (*)	~7 s (*)
Descent time	~3.5 s (*)	~4.5 s (*)	~3.5 s (*)	~4.5 s (*)
Emergency descent device	YES (excludable)			
Emergency descent time	~1.2 s (*)	~1.5 s (*)	~1.2 s (*)	~1.5 s (*)
Rising obstacle detection device	YES			
Release device	YES			
Power supply voltage	220-240V ~ 50/60Hz			
Max. power	575 W (*)			
Hydraulic pump unit protection class	IP67			
Type of use	Intensive use (Traffic)			
Impact resistance	38,000 J		67,000 J	
Break in resistance	128,000 J		207,000 J	
Pit weight	55 Kg	65 Kg	55 Kg	65 Kg
Traffic bollard weight	112 Kg	130 Kg	112 Kg	130 Kg
Operating ambient temperature	-15 °C / +55 °C			
Operating ambient temperature with heater	-25 °C / +55 °C			
Slow lowering	YES			

(*) Data referred to 230V-50Hz

ELECTRONIC EQUIPMENT

Item	Item code
Electronic control unit	117300



J275 HA V2



PAINTED STEEL VERSIONS

Models	Height	Finish	Item code
J275 HA V2 600	600 mm	painted steel	116006
J275 HA V2 800	800 mm		116007

The product comes with:

- 7 mm thick steel cylinder with cathoporesis treatment and painted
- powder paint, dark grey metallised RAL 7021
- flashing light ring with central LED
- acoustic movement buzzer
- emergency lowering in the event of a power cut (can be excluded)
- manual release key for manual emergency lowering (1 pc.)



AISI 316L STAINLESS STEEL VERSIONS

Models	Height	Finish	Item code
J275 HA V2 600	600 mm	satin-finished AISI 316 L stainless steel	116036
J275 HA V2 800	800 mm		116037

The product comes with:



- 6 mm thick stainless steel cylinder with satin-finished treatment
- flashing light ring with central LED
- acoustic movement buzzer
- emergency lowering in the event of a power cut (can be excluded)
- manual release key for manual emergency lowering (1 pc.)

INSTALLATION ACCESSORIES

Item	Item code	
Pit JP 275/600 for bollard H600 complete with counter frame	1161001	
Pit extension JP 275/800* for bollard H800*	1161011	

(*) For the 800 mm version the following two elements must be ordered: 1161001 + 1161011.

OPTIONAL ACCESSORIES

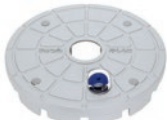
Item	Item code	
Pit heater JH275 (to extend operation up to -25°C)	116200	
Pit cover JC275	116201	
J275 anti-burglar head	116104	





J275 SA SEMI-AUTOMATIC retractable traffic bollard

1. Power supply and wiring not required
2. Simple and safe movement, thanks to the specific release key
3. Low position lock guaranteed against accidental release



J275 SA

DIMENSIONS AND TECHNICAL SPECIFICATIONS

Model	J275 SA H600	J275 SA H600 Stainless steel
Type of operator	Single-acting gas operator	
Cylinder height from ground	600 mm	
Cylinder diameter	275 mm	
Cylinder material	Steel S235JR EN 10219 (7 mm thick)	Satin-finished AISI 316L (6 mm thick)
Cylinder treatment	Cataphoresis and polyester powder paint, dark grey metallised RAL 7021	Satin finish
Release device	Key operated (supplied)	
Impact resistance	38,000 J	67,000 J
Break in resistance	128,000 J	207,000 J
Pit weight	55 Kg	
Traffic bollard weight	70 Kg	



PAINTED STEEL VERSION

Model	Height	Finish	Item code
J275 SA 600	600 mm	painted steel	116050

The product comes with:

- 7 mm thick steel cylinder with cataphoresis treatment and painted
- powder paint, dark grey metallised RAL 7021
- flashing light ring with central LED*
- mechanical lock in raised position with special release key (2 pcs.)

AISI 316L STAINLESS STEEL VERSION

Model	Height	Finish	Item code
J275 SA 600	600 mm	satin-finished AISI 316L stainless steel	116060

The product comes with:

- 6 mm thick stainless steel cylinder with satin-finished treatment
- flashing light ring with central LED*
- mechanical lock in raised position with special release key (2 pcs.)

(*) The power supply unit (24 Vdc) and the cable (2x1.5 mm) for the illuminated ring are not supplied.

INSTALLATION ACCESSORIES

Item	Item code	
Pit JP 275/600 for bollard H600 complete with counter frame	1161001	

OPTIONAL ACCESSORIES

Item	Item code	
Release keys kit (5 keys)	390084	
Pit cover JC275	116201	



J275 F FIXED traffic bollard

1. Power supply and wiring not required
2. Simple installation and limited digging operations
3. Observance of aesthetic consistency in mixed installations with other retractable bollards
4. Possibility to remove the bollard to temporarily open the pedestrian area to traffic



741

601

DIMENSIONS AND TECHNICAL SPECIFICATIONS

Model	J275 F H600	J275 F H800	J275 F H600 Stainless steel	J275 F H800 Stainless steel
Cylinder height from ground	600 mm	800 mm	600 mm	800 mm
Cylinder diameter	275 mm			
Cylinder material	Steel S235JR EN 10219 (4 mm thick)		AISI 316L satin finishing (3 mm thickness)	
Cylinder treatment	Cataphoresis and polyester powder paint, dark grey metallised RAL 7021		Satin finish	
Reflective strip height	55 mm			
Standard reflecting strip colour	Orange			
Break in resistance	35,000 J		59,000 J	
Total weight	34 Kg	38 Kg	34 Kg	38 Kg

J275 F



PAINTED STEEL VERSIONS

Models	Height	Finish	Item code
J275 F 600	600 mm	painted steel	116020
J275 F 800	800 mm		116021

The product comes with:

- a 7 mm steel cylinder cathodolysis treated and painted
- powder coated dark grey metallised RAL 7021
- flashing light ring with central LED*

AISI 316L STAINLESS STEEL VERSIONS

Models	Height	Finish	Item code
J275 F 600	600 mm	satin-finished AISI 316L stainless steel	116040
J275 F 800	800 mm		116041

The product comes with:

- 6 mm thick stainless steel cylinder with satin-finished treatment
- flashing light ring with central LED*

(* The power supply unit (24 Vdc) and the cable (2x1.5 mm) for the illuminated ring are not supplied.

INSTALLATION ACCESSORIES

Item	Item code	
Fixed bollard fixing frame JPF275	116120	

OPTIONAL ACCESSORIES

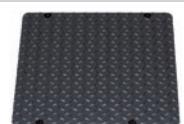
Item	Item code	
Pit cover JC275	116201	





Bollards for the perimeter protection of critical areas

Traffic bollards range specifically dedicated to perimeter protection and regulation of vehicular access to restricted areas with special security requirements

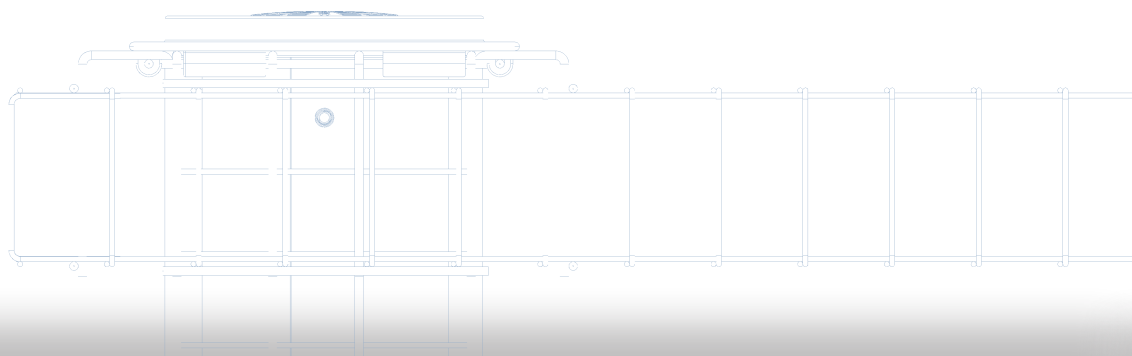

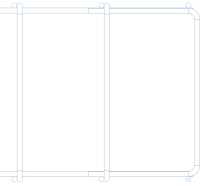

1. J275 2K20 RANGE

J275 2K20 Range is recommended for vehicular access control and perimeter protection in critical areas. Able to arrest a 7.500kg truck driving at 50km/h in dual installation

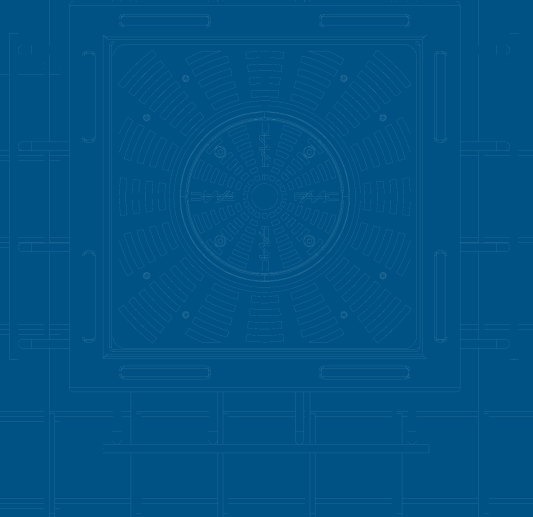



J275 HA 2K20 Automatic perimeter security bollard

1. Performance certified according to PAS 68 and IWA 14-1 standards. Able to withstand impact with a 7500 kg truck driven at 50 km/h in a double unit configuration
2. Guaranteed for high frequency use
3. Simplified maintenance (possible with just one person)
4. Hydraulic control unit integrated in the bollard
5. "Gentle stop" function to ensure a gentle stop on the low limit switch
6. Anti-tamper head and protected by a security lock with encrypted key to prevent unauthorized lowering



DIMENSIONS AND TECHNICAL SPECIFICATIONS

Model	J275 HA 2K20	J275 HA 2K20 INOX
Type of operator	Hydraulic Actuator	
Cylinder height from ground	800 mm	
Cylinder diameter	275 mm	
Cylinder treatment	Cataphoresis and polyester painting	Aisi 316 satin-finish stainless steel
Reflective strip height	55 mm	
Standard reflecting strip colour	White	
Rising time	~8 s	
Descent time	~4,5 s	
Emergency descent device	YES (OPTIONAL)	
Emergency descent time	~2 s	
Rising obstacle detection device	YES (OPTIONAL)	
Release device	yes	
Slow lowering	yes	
Power supply voltage	220-240V - 50/60Hz	
Max. power	575 W (*)	
Hydraulic pump unit protection class	IP67	
Type of use	Perimeter protection	
Break in resistance	673,000 J dual unit	
Pit weight	100 kg	
Traffic bollard weight	170 kg	
Operating ambient temperature	-15°C / +55°C	
Operating ambient temperature with heater	-25°C / +55°C	
Load class (EN 124)	C250 (25t)	

ELECTRONIC EQUIPMENT

Item	Item code
Electronic control unit	117300



J275 HA 2K20



PAINTED STEEL VERSIONS

Model	Height	Finish	Item code
J275 HA 2K20	800 mm	painted steel	116401

The product comes with:

- steel cylinder with cathaphoresis treatment and metallised dark grey powder coated painting
- flashing LED lights ring
- movement signal (acoustic buzzer)
- anti-tampering head with encrypted release key to access the emergency manual lowering device
- hydraulic lock in raised position (in case of a power cut)

AISI 316L STAINLESS STEEL VERSIONS

Model	Height	Finish	Item code
J275 HA 2K20	800 mm	satin-finished AISI 316 L stainless steel	116431

The product comes with:

- AISI 316L satin-finished stainless steel cylinder
- flashing LED lights ring
- movement signal (acoustic buzzer)
- anti-tampering head with encrypted release key to access the emergency manual lowering device
- hydraulic lock in raised position (in case of a power cut)

INSTALLATION ACCESSORIES

Item	Item code
Pit J275 2K20	116140

OPTIONAL ACCESSORIES

Item	Item code	
Pit heater JH275 (to extend operation up to -25°C)	116200	
Pit cover JC275	116201	
Pressure switch	116210	
Solenoid valve group	116211	





J275 F 2K20 Fixed perimeter security bollard

1. Power supply and wiring not required
2. «Shallow Mounted» design: minimum hole depth required
3. Visually identical to the retractable (HA) models, making it perfect for mixed installations



DIMENSIONS AND TECHNICAL SPECIFICATIONS

Model	J275 F 2K20 H800	J275 F 2K20 H800 INOX
Cylinder height from ground	800 mm	
Cylinder diameter	275 mm	
Cylinder treatment	Cataphoresis and polyester painting	Satin finish
Reflective strip height	55 mm	
Standard reflecting strip colour	Yellow	
Break in resistance	656.000 J	
Total weight	110 Kg	

J275 F 2K20



PAINTED STEEL VERSIONS

Model	Height	Finish	Item code
J275 F 2K20	800 mm	painting steel	116420

The product comes with:

- steel cylinder with cathoresis treatment and metallised dark grey powder coated painting
- flashing LED lights ring*

AISI 316L STAINLESS STEEL VERSIONS

Model	Height	Finish	Item code
J275 F 2K20	800 mm	satin-finished AISI 316 L stainless steel	116440

The product comes with:

- AISI 316L satin-finished stainless steel cylinder
- flashing LED lights ring*

(*) The power supply unit (24 Vdc) and the cable (2x1,5 mm) for the flashing light are not supplied.

HEADQUARTERS

ITALY

FAAC S.p.A. - Soc. Unipersonale
Via Calari 10 - 40069 Zola Predosa (BO)
Tel. +39 051 61724
it.info@faacgroup.com - www.faacgroup.com

SUBSIDIARIES ASIA - PACIFIC

FAAC MALAYSIA
MAGNETIC CONTROL SYSTEMS SDN BHD
Selangor, Malaysia
tel. +60 3 5123 0033
www.faac.biz

AUSTRALIA

FAAC AUSTRALIA PTY LTD
Regents Park, Sidney, NSW
www.faac.com.au

AUSTRIA

FAAC GMBH
Salzburg, Austria
tel. +43 662 85333950
www.faac.at

BENELUX

FAAC BENELUX NV/SA
Jabbek, Belgium
tel. +32 50 320202
info@faacbenelux.com
www.faacbenelux.com

FAAC BV
Doetinchem, The Netherlands
tel. +31 314 369911
faacbv.info@faacgroup.com
www.faacbv.com

BRAZIL

INDÚSTRIAS ROSSI ELETROMECÂNICA LTDA
Brasília DF, Brazil
tel. +55 61 33998787
www.rossiportoes.com.br

CHINA

FAAC SHANGHAI
Shanghai, China
tel. +86 21 68182970
www.faacgroup.cn

FRANCE

FAAC FRANCE
Saint Priest - Lyon, France
tel. +33 4 72213020
www.faac.fr

FAAC FRANCE - AGENCE PARIS
Massy - Paris, France
tel. +33 4 72213020
www.faac.fr

FAAC FRANCE - DEPARTEMENT VOLETS
Saint Denis de Pile - Bordeaux, France
tel. +33 5 57551890
www.faac.fr

GERMANY

FAAC GMBH
Freilassing, Germany
tel. +49 8654 49810
www.faac.de

INDIA

MAGNETIC FAAC INDIA PVT LTD.
Chennai - India
Tel. +91 44 421 23297
info@magnetic-india.com
www.faacindia.com

IRELAND

NATIONAL AUTOMATION LTD
Co. Roscommon, Ireland
tel. +353 71 9663893
www.nal.ie

MIDDLE EAST

FAAC MIDDLE EAST FZE
Dubai, UAE
tel. + 971 4 3724190
www.faac.ae

POLAND

FAAC POLSKA SP.ZO.O
Warszawa, Poland
tel. +48 22 8141422
fax +48 22 8142024
www.faac.pl

RUSSIA

FAAC RUSSIA
Moscow, Russia
tel. +7 (495) 646 87 40
www.faac.ru

SCANDINAVIA

FAAC NORDIC AB
Perstorp, Sweden
tel. +46 435 779500
www.faac.se

SOUTH AFRICA

CENTURION SYSTEMS PTY LTD
Johannesburg, South Africa
tel. +27 11 699 2400
www.centsys.co.za

SPAIN

CLEM, S.A.U.
San Sebastián de los Reyes - Madrid, Spain
tel. +34 91 3581110
www.faac.es

SWITZERLAND

FAAC AG
Altdorf, Switzerland
tel. +41 41 8713440
www.faac.ch

UNITED KINGDOM

FAAC UK LTD.
Basingstoke Hampshire, UK
tel. +44 1256 318100
www.faac.co.uk

U.S.A.

FAAC INTERNATIONAL INC
Rockledge, Florida - U.S.A.
tel. +1 866 925 3222
www.faacusa.com

FAAC INTERNATIONAL INC
Fullerton, California - U.S.A.
tel. +1 714 446 9800
www.faacusa.com